

This manual is for reference and historical purposes, all rights reserved.

This page is copyright© by M. Butkus, NJ.

This page may not be sold or distributed without the expressed permission of the producer

I have no connection with any camera company

On-line camera manual library

This is the full text and images from the manual. This may take 3 full minutes for the PDF file to download.

If you find this manual useful, how about a donation of \$3 to: M. Butkus, 29 Lake Ave., High Bridge, NJ 08829-1701 and send your e-mail address so I can thank you. Most other places would charge you \$7.50 for a electronic copy or \$18.00 for a hard to read Xerox copy.

This will allow me to continue to buy new manuals and pay their shipping costs.

It'll make you feel better, won't it?

**If you use Pay Pal or wish to use your credit card,
click on the secure site on my main page.**

MAMIYA C220

professional

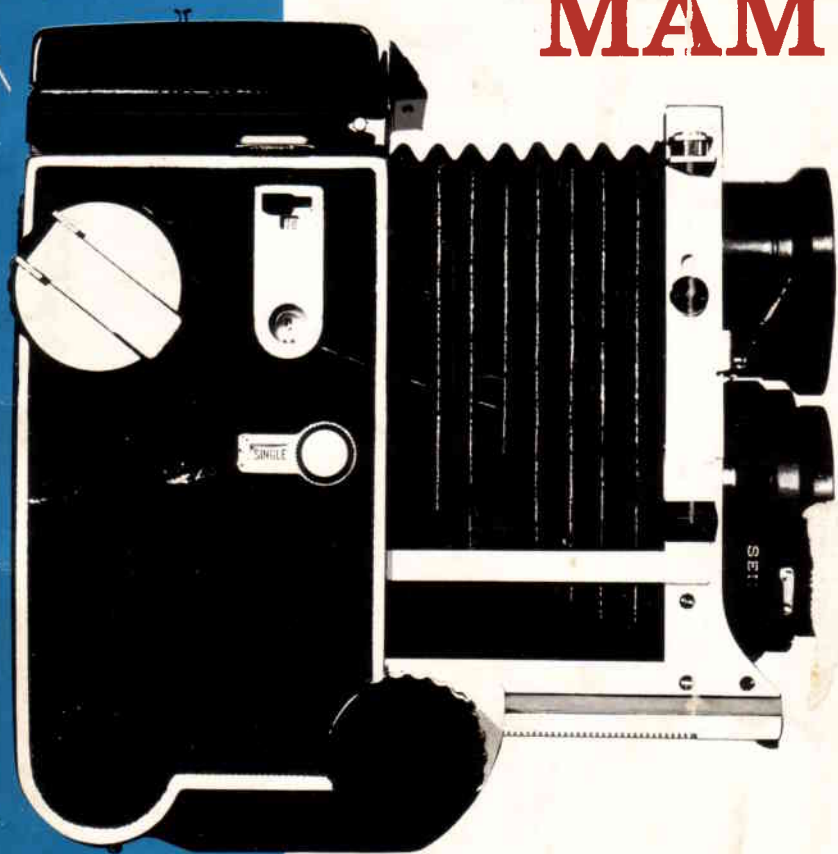

INSTRUCTIONS

CONTENTS

We are highly gratified that you have selected the MAMIYA C220 from among so many makes of cameras on the market. Before using the camera, please read these instructions very carefully, and learn the correct method of handling it. By becoming completely familiarized with the MAMIYA C220, you can make the most of the splendid opportunities this fine camera offers for many years to come.

Mamiya C series twin-lens reflex cameras are highly reputed by professional cameramen the world over as the only twin-lens reflex cameras (2 1/4 in. square format) with interchangeable lenses. This MAMIYA C220 is a popular version of the versatile Mamiya C series with all of the series' characteristic versatilities topped by further improvements, especially in minimizing size and weight, ease of handling, and genuine economy.

Not only designed for professional cameramen, the superb MAMIYA C220 is also ideal for many advanced amateurs who wish to take advantage of the fine details in enlargements which only a large-format camera offers.

The MAMIYA C220 accepts all interchangeable lenses of the current Mamiya C series as well as all of the accessories except the single-exposure attachment. *W. J. J.*

In addition, various new accessories have been designed for this model. With the wide selection of all these interchangeable lenses and accessories, you can further widen your scope of photography by making the most of the the MAMIYA C220 offers.

	page
Read These Instructions Before Using Your MAMIYA C220	2
NOMENCLATURE	5
Opening and Closing the Back Cover	7
Before Loading Film.....	7
Loading and Unloading Film.....	9
Handling the Focusing Hood.....	11
Changing the Focusing Hood	12
Taking Pictures	13
Precautions on Shutter Operations	14
Using the Multiple Exposure Selector	14
When No Film is Loaded in the Camera.....	15
Precautions on Close-Up Photography	15
Exposure Correction.....	15
Correcting Parallax	16
Reading the Distance Scale	16
Photographing by Flash Unit	17
Changing Lenses	18
Interchangeable Lenses and Accessories for MAMIYA C220	19
Angle of View Changes by Interchanging Lenses	21
Specifications of Interchangeable Lenses	22
Accessories	23
4 Table	27

■ Read These Instructions Before Using Your MAMIYA C220

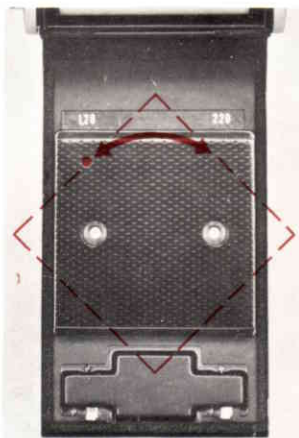

Adjust the position of the pressure plate according to the film used (120 roll film or 220 roll film).

*See page 8
for details.*

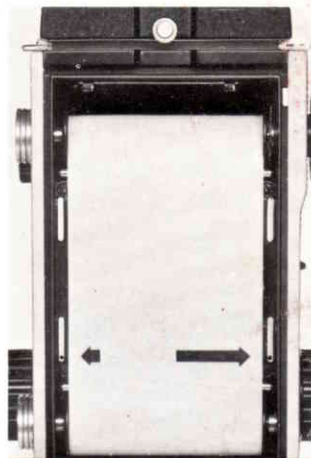

When loading film, insert both film spools correctly.

*See page 9
for details.*



When closing the back cover, firmly press both sides of the back cover catch button.

*See page 7
for details.*

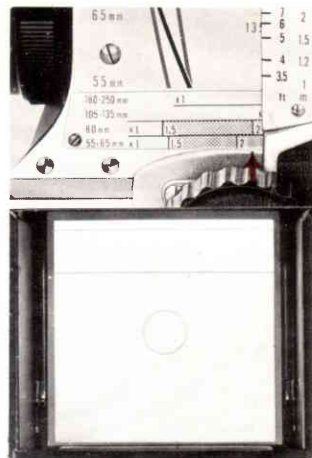

When taking close-up shots, be careful of exposure correction and parallax compensation.

*See page 15
for details.*

Read These Instructions Before Using Your MAMIYA C220

When this camera is under any of the conditions described below, the shutter release button cannot be depressed. In this case, absolutely do not use force.

1. When UNLOCK appears in the lens change knob window.



2. When the shutter is uncocked.

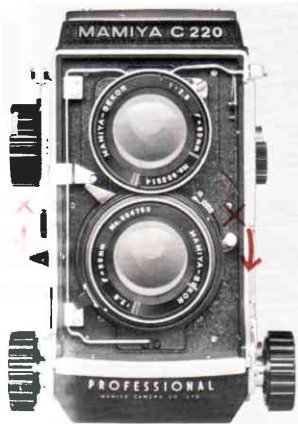

3. When SINGLE appears in the multiple exposure counter window.

(1) When film is not loaded (exposure counter set at "0").

(2) When the film has not been wound.

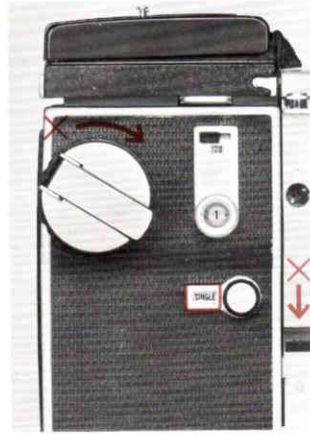

selector window, and...

(3) When the shutter release button has already been pressed.



(4) When the last film in roll is exposed (after 12 or 24 exposures).



To freely release the shutter or for multiple exposures, turn the multiple exposure selector until MULTI appears in the selector window.

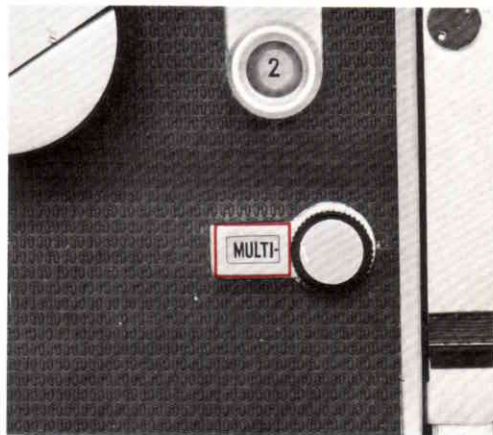

See page 14 for details.

NOMENCLATURE

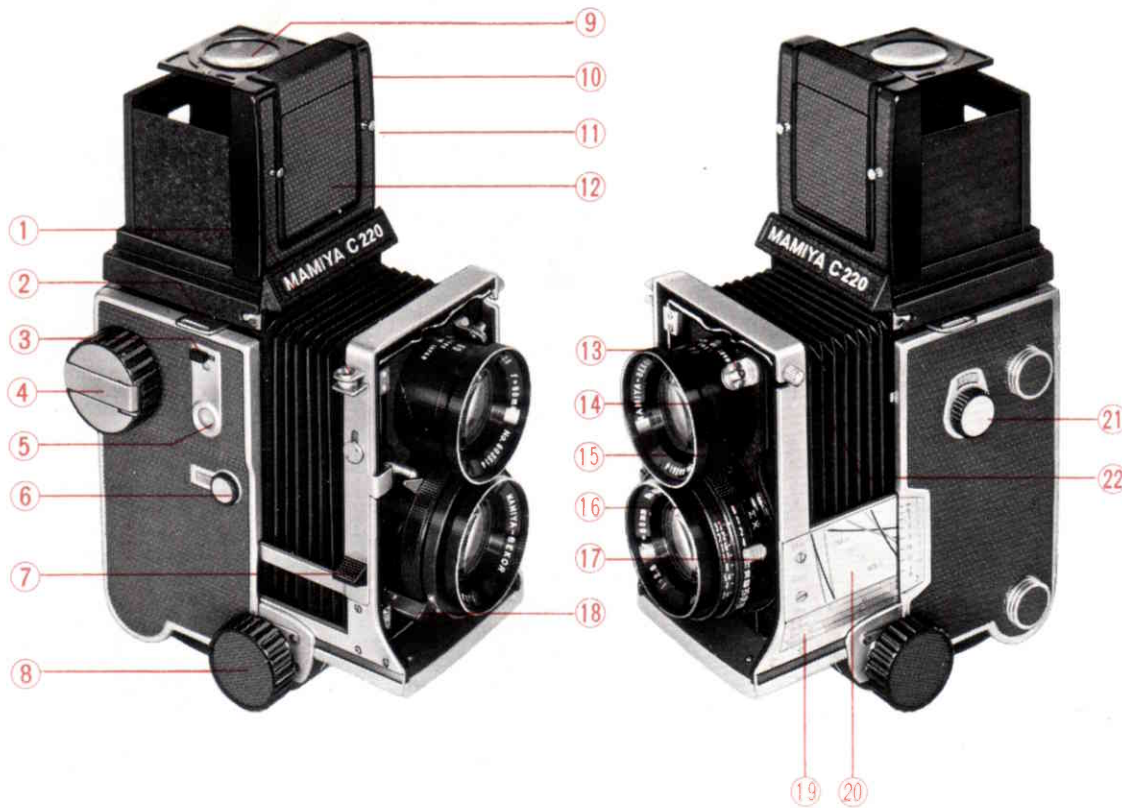

1. Cable release socket
2. Strap eyelet
3. Counter change-over button
4. Film wind knob
5. Exposure counter
6. Multiple exposure selector
7. Shutter release button
8. Focusing knob
9. Magnifying glass
10. Finder frame
11. Sportsfinder mask stud
12. Sportsfinder flap
13. Synchroflash terminal
14. Synchroflash M-X selector
15. Shutter speed ring
16. Aperture ring
17. Shutter cocking lever
18. Aperture control knob
19. Exposure correction scale
20. Distance scale
21. Lens change knob
22. Lens catch

- 23. Eye opening for sportsfinder
- 24. Focusing hood lock screw
- 25. Back cover catch button
- 26. Film indicator window
(120/220)
- 27. Tripod socket
- 28. Indicator for spool attaching
position
- 29. Take-up spool chamber
- 30. Spool change knob
- 31. Start marks
- 32. Film chamber
- 33. Spool change knob
- 34. Film pressure plate

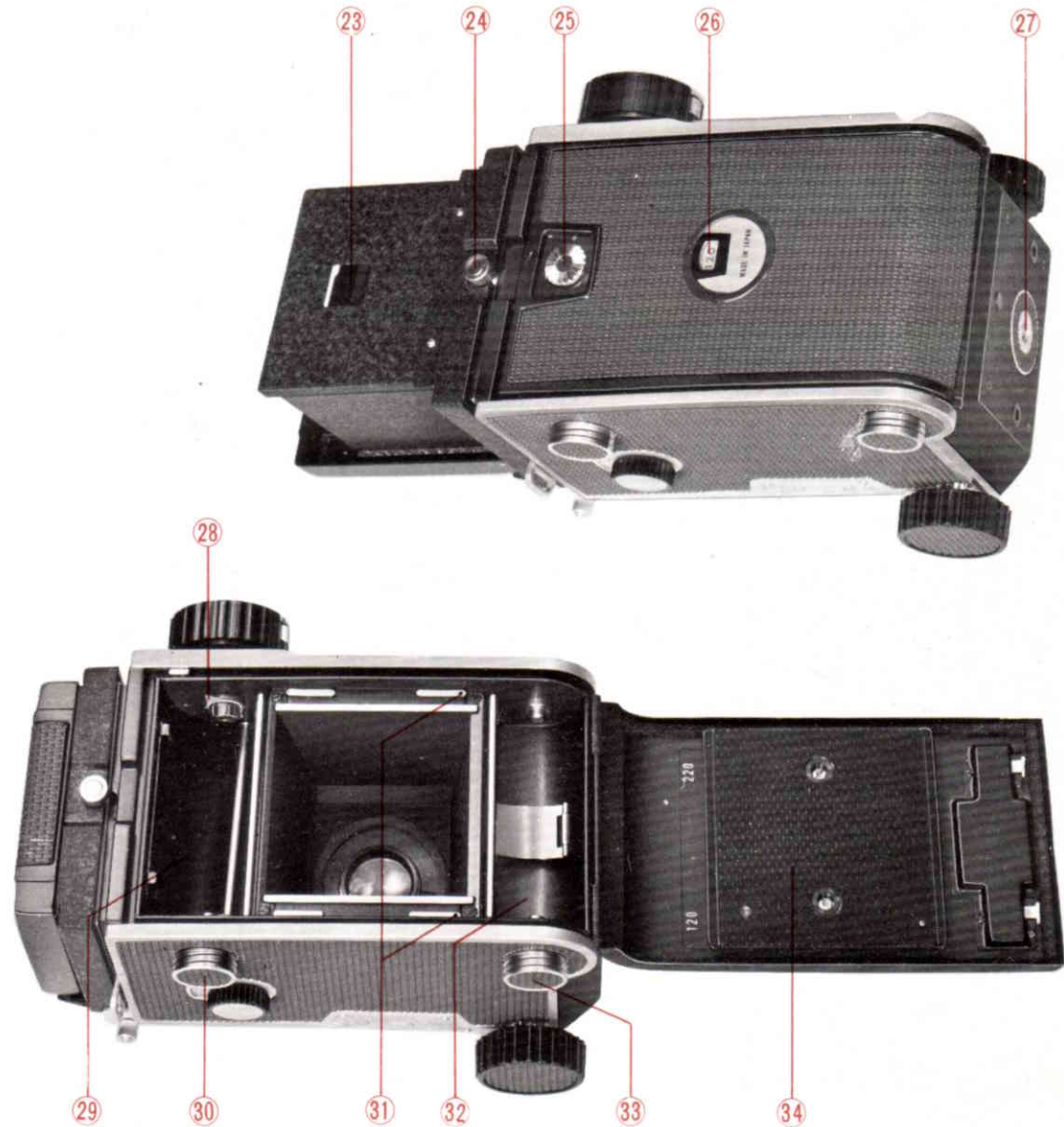

Opening and Closing the Back Cover



Twist the back cover catch button (25) until the red mark on the button faces upward. Then, by pressing the button in the direction indicated on the back cover, the back cover will open. The figure in the exposure counter automatically returns to "0" when the back cover opens.

When closing the back cover, firmly press both sides of the back cover catch button, making sure that neither side of the back cover is open or loose. Unless the back cover is closed tightly, the automatic film stopper will not work. Also, if only one side of the back cover is pressed when closing, the automatic film stopper may not function.

When the back cover is closed, by twisting the back cover catch button counterclockwise until the red mark of the button is on the left side, the back cover can be locked. If the button is twisted and the red mark moved to the left side before closing, the back cover will automatically lock when closed.

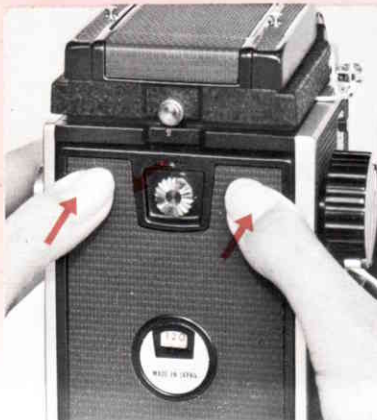

Before Loading Film

This camera accepts either 120 or 220 roll film. It has an automatic film stopper and a double exposure prevention device. Take the following steps before loading a film:

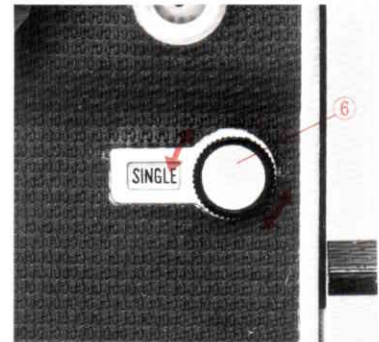

1. Twist the multiple exposure selector (6) until **SINGLE** appears in the window by the selector.

This action locks the shutter release button until the film is wound, preventing accidental double exposures.

PRECAUTIONS

Observe the previously mentioned steps before loading a roll of film. Especially note that if the pressure plate is not correctly positioned for the size of film used, do not expect sharp, well-focused negatives.

Set the counter change-over button before loading a roll film, and never change it while the film is loaded. Should you carelessly change this button while film is loaded, this is what would happen:

- (1) When the exposure counter number does not exceed 10, and you have not yet released the shutter for the tenth exposure...
 - (a) When 120 is changed to 220, the counter number clicks to 24.
 - (b) When 220 is changed to 120, the counter number stops at 12, and the automatic film stopper no longer functions, freeing the film without stopping.
- (2) When the number is 11 or more, the counter change-over function will not be changed. In this case, the automatic film stopper functions according to the film setting originally made.
- (3) After making 13 or more exposures, should you inadvertently change the counter change-over button which was originally set at 220 to 120, the exposure counter will not return to "0" when the back cover is opened. In this case, twist the counter change-over button back to 220, the exposure counter will return to "0".

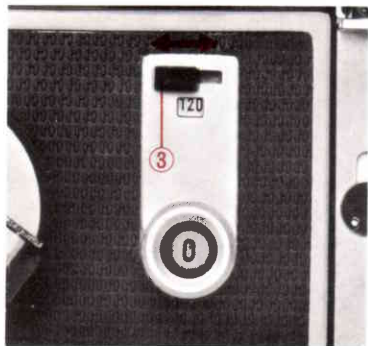

2. Adjust the automatic film stopper for the film to be used (120 or 220 roll film).

Slide the counter change-over button (3) to show the same figure in the window immediately below the button as that of the film (120 or 220). When 120 shows in the window, the automatic film stopper functions until 12 exposures have been made. When 220 shows in the window, the stopper functions until 24 exposures have been made.

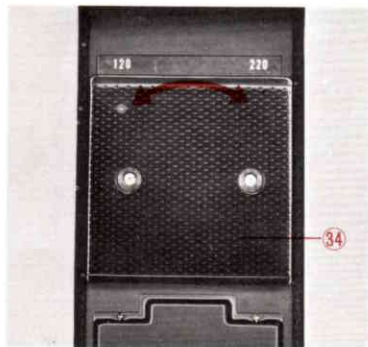

3. Adjust the position of the pressure plate according to the film used.

Open the back cover, twist the pressure plate (34) either to the right or left 90 degrees until the red mark on the pressure plate matches either 120 or 220. The figure 120 or 220 will appear in the film indicator window (26), informing the user of the loaded film size when the back cover is closed.

■ Loading and Unloading Film

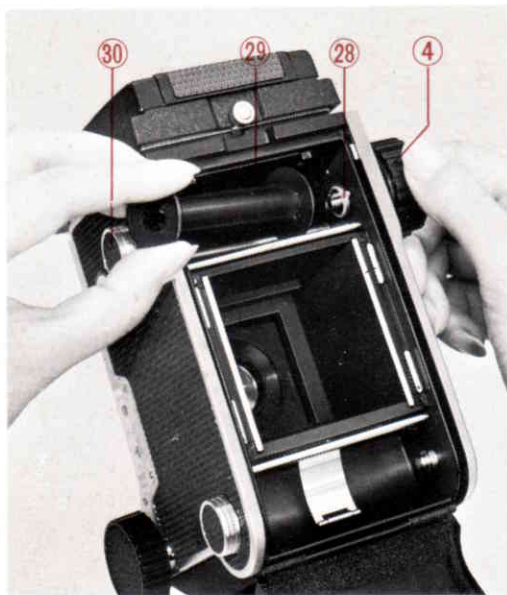

1. Open the back cover and insert a take-up spool in the take-up spool chamber (29). While turning the film wind knob (4), by turning the indicator for spool-attaching position (28) in the take-up spool chamber toward the operator, attaching the spool becomes very easy. Pull out the spool change knob (30), put the spool into the axis, and reinsert the spool change knob.

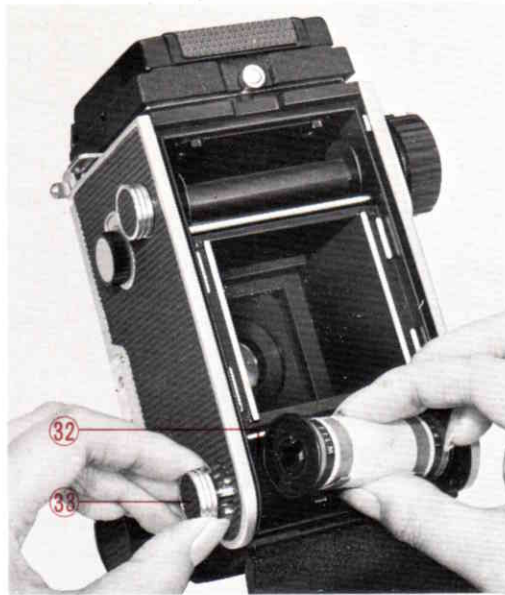

2. Pull out the spool change knob (33), and insert a roll of film in the film chamber (32).

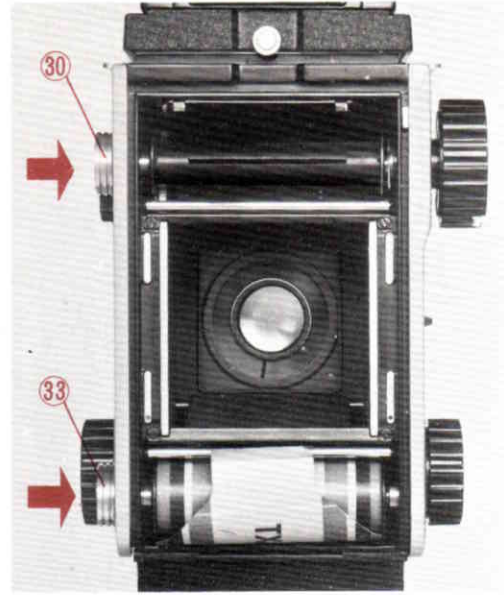

PRECAUTIONS

By turning the spool change knobs (30) and (33) either to the right or left after pulling them outward, the knobs stay at their protruded positions. Turn the knobs backward to reinsert them.

If both spool change knobs are not returned to their original positions after loading a film, unbalanced film winding will result. When either spool change knob protrudes freely from the camera body, push it from the outside to its original inserted position.

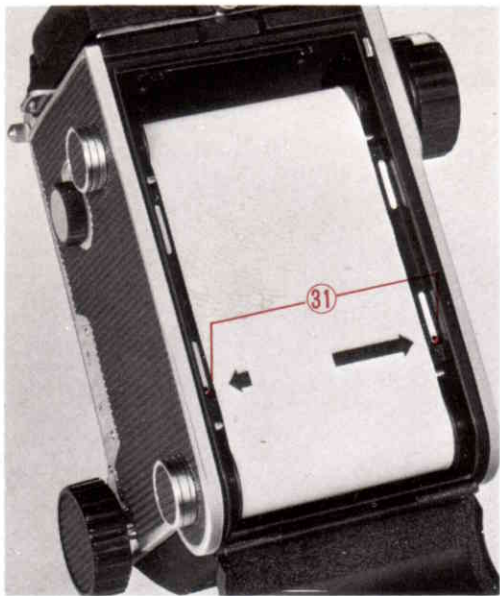

3. Pull out the leader paper of the film and guide it into the slit of the take-up spool, turn the film wind knob (4) clockwise until the start mark on the leader paper matches the start marks (31) on the camera, then close the back cover.



PRECAUTION

When closing the back cover, firmly press both sides of the back cover catch button. Twist the button counterclockwise, so that the back cover cannot open unexpectedly.

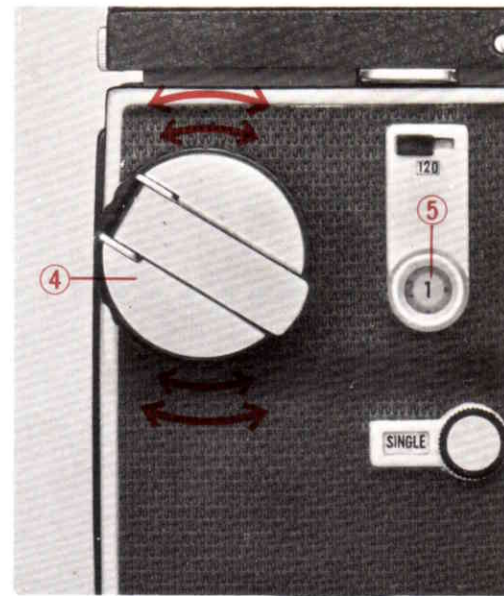

4. Turn the film wind knob (4) clockwise until the exposure counter registers 1 and the knob stops. Now the camera is ready for the first exposure.

Film winding can be accomplished by several small turns of the knob while keeping the fingers on the knob, just like winding a watch. Pulling out the crank of the knob and utilizing the crank expedites film winding.

■ Handling the Focusing Hood

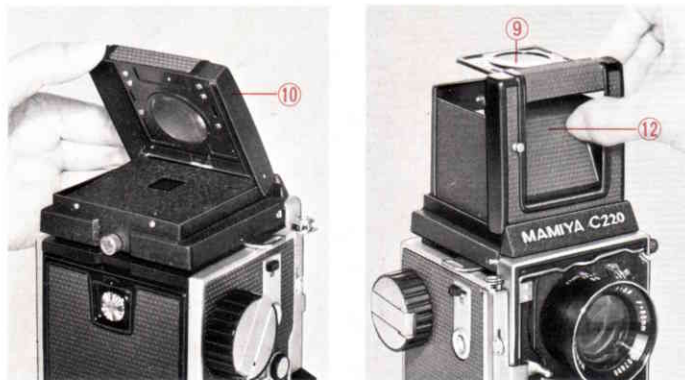

By pulling up the rear of the finder frame (10), the focusing hood automatically springs up into position. By pushing in the top of the sportsfinder flap (12) at the center of the finder frame, the magnifying glass swings up into position. While looking into the ground glass focusing screen in this position, turn the focusing knob (8) to focus. After focusing, push down the magnifying glass, and decide the photo composition by using the complete ground glass focusing screen as a guide.

Using the Focusing Hood as a Sportsfinder

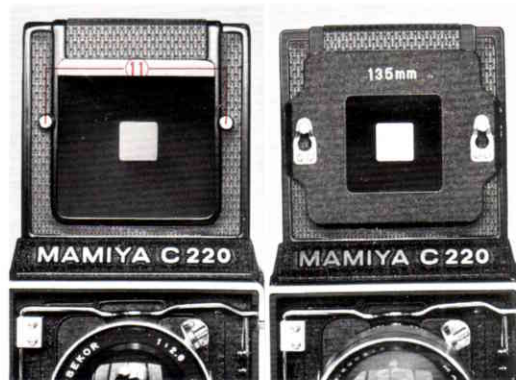

1. By pulling up the magnifying glass and pushing down the sportsfinder flap, and by attaching the latter to the catch at the bottom of the focusing hood, the hood can be used as a sportsfinder for the 80mm standard lens. For other lenses, attach the particular sportsfinder mask for the lens used at the sportsfinder mask stud (11), adjusting for the change in field-of-view.

Changing the Focusing Hood

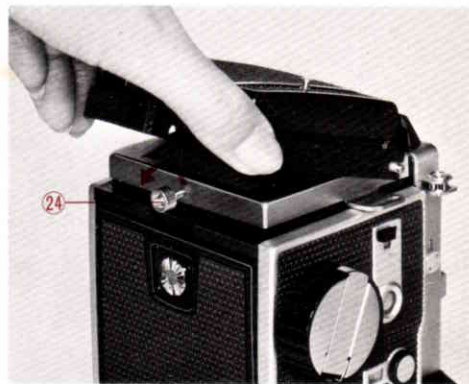

2. To return the sportsfinder flap (12), by slightly pushing inward on the side plate of the hood (on the side of the film wind knob), the flap will automatically return to its original position.

Folding the Focusing Hood

Return the sportsfinder flap, push down the magnifying glass, fold the side plates inward and the back plate downward, finally folding the finder frame (10).

The focusing hood can be replaced with various finders available for this camera as accessories.

How to Remove the Focusing Hood

By turning the focusing hood lock screw (24) counterclockwise to loosen it, pull back the hood and move it upward; then the hood can be taken off.

How to Attach a Focusing Hood

Match the grooves on the hood's front both sides to the pins of the camera body, fit the groove on the hood's rear to the focusing hood lock screw, then fasten it.

Taking Pictures

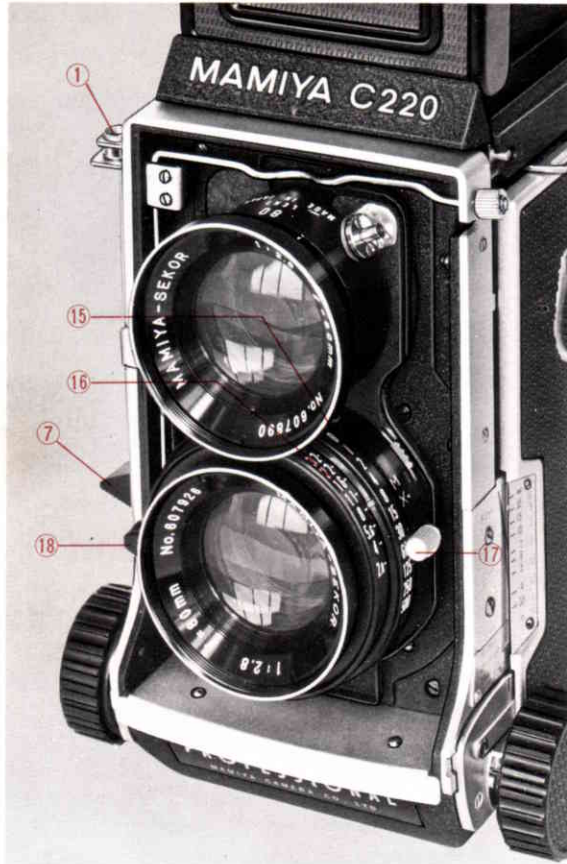

1. After focusing, turn the shutter speed ring (15) and set the shutter speed; then adjust the aperture of the lens by turning the aperture control knob (16). Cock the shutter by pushing down the shutter cocking lever (17). Any of three procedures mentioned above can be performed first. Now the camera is prepared for taking pictures.
2. Release the shutter by pressing the shutter release button (7). When a cable release is used, screw it into the cable release socket (1).
3. After each exposure, wind the film by turning the film wind knob, then follow the same routine as mentioned above.
4. When you have exposed a roll of film, wind up all the leader paper of the film, removing the roll film from the camera.

Winding Up the Roll Film

To remove the film before exposing the entire roll, or to wind up a short roll of film after exposure (certain color films have only 6 exposures), turn the film wind knob and cock the shutter as when preparing for another exposure. By turning the film wind knob while the shutter release button (7) is depressed, the roll film can be completely wound without stopping.

■ Precautions on Shutter Operations

Be Sure to Cock the Shutter, Before Press the Shutter Release Button

When using a lens whose shutter release lever can be moved without being cocked (like the 80mm f/3.7 lens), the shutter release button can be pressed without previous cocking; however, the shutter diaphragm does not open and no picture can be taken. Even if you realize it after pressing the button and try to cock and release the shutter, the shutter release button will not move because of the double-exposure prevention mechanism. In this case, by twisting the multiple exposure selector (6) until MULTI appears in the window of the selector, the shutter can be released.

When you depress the shutter release button on the half way and give up the shutter releasing action (as when you miss a chance to take a picture), the shutter release button may not function for the second shot. In this case, also, turning the multiple exposure selector as described in the above case, the shutter release button (7) can be depressed.

Using the Multiple Exposure Selector

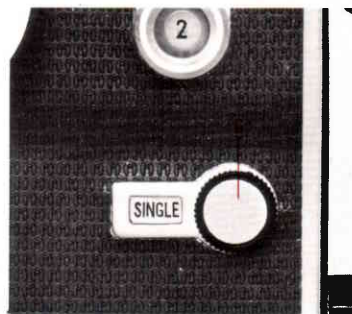

1. When SINGLE appears in the window of the multiple exposure selector (6), an unintentional double exposure can be prevented. In this case, the shutter release button cannot be depressed unless the film wind knob is wound for another exposure.

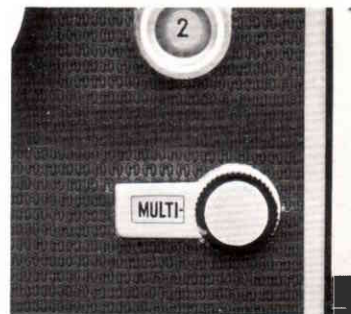

2. When MULTI appears in the window, the shutter release button can be depressed whether the film is advanced or not.

To make a multiple exposure, or when you want to click the shutter without taking a picture, follow the method described in 2, above. But make sure that the multiple exposure selector is turned to SINGLE thereafter to avoid inadvertent multiple exposures.

When No Film is Loaded in the Camera

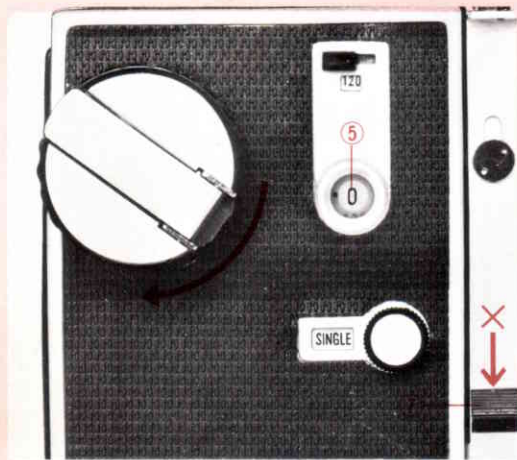

When no film is loaded in the camera, the number in the exposure counter remains at "0", even when the film wind knob is turned, and the shutter release button cannot be depressed. However, when a take-up spool is in the take-up spool chamber, the counter may be advanced, depending upon the type of spool. Under this condition, it is not desirable to turn the film wind knob.

Precautions on Close-Up Photography

When the distance between the film and the lens increases for close-up photographing, it becomes necessary to increase exposure and to compensate for parallax by adjustment.

Exposure Correction

For correcting exposures, use the exposure correction scale (19) on the left side of the camera body. After focusing, read the multiplication factor for the lens used, and increase the exposure by this factor. For example, when an 80mm lens is focused on a subject and the exposure correction scale shows like that in the photo, the exposure must be doubled. If a hand-held lightmeter indicates a combination of 1/60 sec. at f/8, the actual combination must be 1/60 sec. at f/5.6 or 1/30 sec. at f/8.

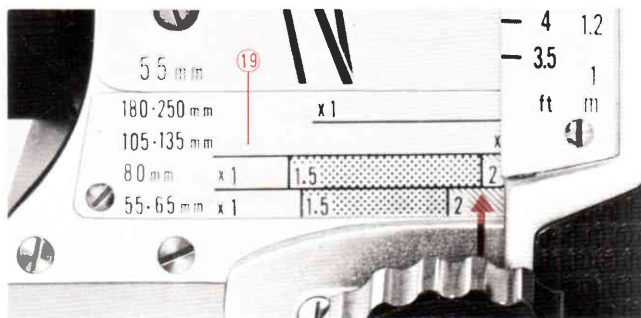

Reading the Distance Scale

Correcting Parallax

When the camera is hand-held, use the parallax correction scale on the ground glass focusing screen. The greater the distance between the lens and the film, the more parallax increases.

For instance, when the exposure correction scale indicates a 1.5X exposure factor, the area appearing above the corresponding 1.5 line (first line from the lens side) on the ground glass focusing screen will not be recorded on the film. When even nearer close-ups are wanted and the scale shows a factor of 2, the area above the second line on the screen will not be photographed. When the scale lies in between, determine the proper judgment yourself. When the scale shows a factor of 3, the area above approximately the center portion on the ground glass focusing screen will not be photographed.

When using a tripod, you can easily photograph the exact area viewed in the ground glass focusing screen by using the Paramender.

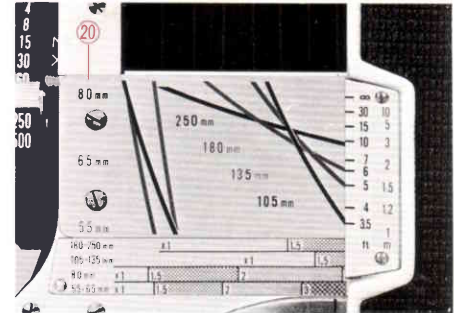
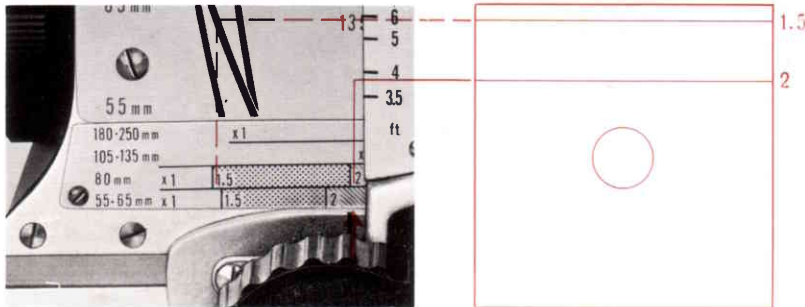

The curve and the scale (shown in the photo) is the distance scale (20) which indicates distance from the film plane to the subject being photographed. The vertical scale on the camera body, which meets the curves written for each lens, shows the distance of the focused subject from the camera. When a flash unit is used for photographing or shoot "blind" with lens focus preset for the distance, this scale is very convenient to use.

■ Photographing by Flash Unit

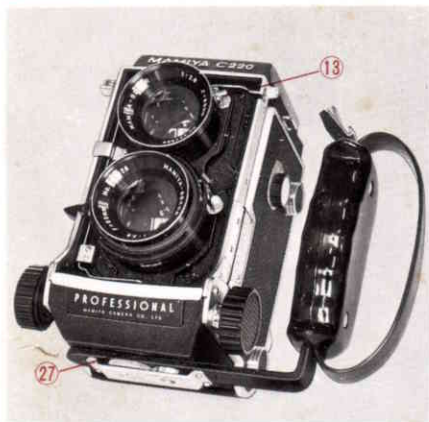

For hand-holding the camera while photographing by flash, attach a grip holder to the tripod socket (27) of the camera body, and attach a flash unit to the accessory shoe on the top of the grip holder. Plug the cord into the synchroflash terminal (13).

When M-class flash bulbs are used, set the synchroflash M-X selector (14) on M to synchronize flash at all shutter speeds.

When an electronic flash unit is used, set the synchroflash M-X selector on X to synchronize flash at all shutter speeds.

This synchroflash M-X selector can be changed even after cocking the shutter. When photographing without flash, keep the selector on X.



FLASH SYNCHRONIZATION TABLE

Contact	Bulb	Shutter Speed										
		B	1	$\frac{1}{2}$	$\frac{1}{4}$	$\frac{1}{8}$	$\frac{1}{15}$	$\frac{1}{30}$	$\frac{1}{60}$	$\frac{1}{125}$	$\frac{1}{250}$	$\frac{1}{500}$
M	M class	○	○	○	○	○	○	○	○	○	○	○
X	Electronic Flash	○	○	○	○	○	○	○	○	○	○	○
	F class	○	○	○	○	○	○	○	○	×	×	×
	M class	○	○	○	○	○	○	○	×	×	×	×

Combinations with the ○ mark synchronize.

Combinations with the × mark do not synchronize.

Changing Lenses

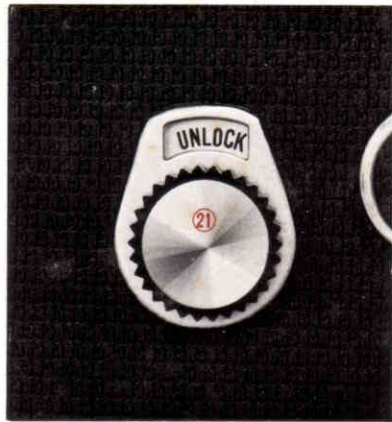

Turn the focusing knob (8) and retract the bellows so that the lens catch (22) moves closest to the body. Turn the lens change knob (21) counterclockwise until the word UNLOCK appears in the window.

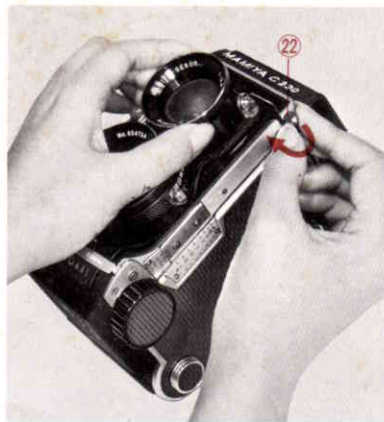

Tip the camera so that the lens faces upward and, while firmly grasping the lens barrel, pinch the head of the lens catch, press the head toward the camera body, push it down to release the lens catch, and remove the lens. To attach another lens to the camera body, hook the lens catch as it was, and turn the lens change knob until the lens locks in place.

PRECAUTIONS

1. While the word UNLOCK appears in the window of the lens change knob, the portion to which the taking lens is attached is protected by a cover from the camera interior to shield the film from exposure to light, and a red warning signal is visible on the ground glass focusing screen.
2. Should this cover be pushed purposely or inadvertently while the lens is removed, light will strike the film. NEVER PUSH IT!
3. After changing a lens, turn the lens change knob (21) until the word LOCK appears in the window; otherwise, the shutter release button cannot be pressed.